



型号(Type): **HR-AA2400 1.2V**

单颗电池规格 Specifications of single cell

标称电压 Nominal voltage		1.2V	
容量 Capacity	0.5C 放电 Discharge		
	最小 Minimum	114min	
	典型 Typical	116min	
尺寸 Dimensions	直径 Diameter	mm 14.5 <sup>-0.7</sup>	
	高 Height	50.5 <sup>-1.5</sup>	
大约重量 Weight(Approximately)		克 gram 30.0	
内阻 Internal Impedance At 1000 Hz		35mΩ (充电后 After Charge)	
充电 Charge	标准 Standard	240mA(0.1C)×16hrs	
	快速 Rapid	1200mA(0.5C)×2.2hrs	
环境温度 Ambient temperature	充电 Charge	标准 standard	0°C to 40°C
		快速 Rapid	0°C to 40°C
	放电 Discharge		-20°C to 50°C
	贮藏 Storage		-20°C to 30°C

典型特征 Typical characteristics

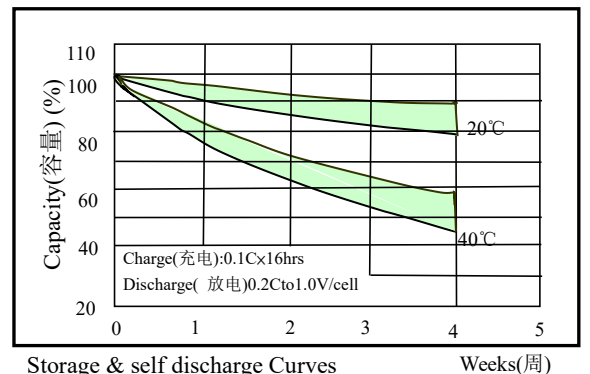
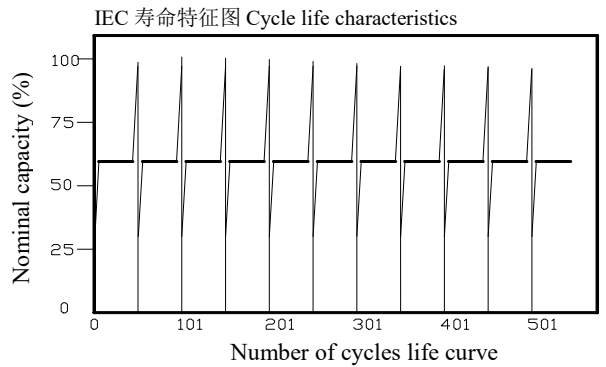
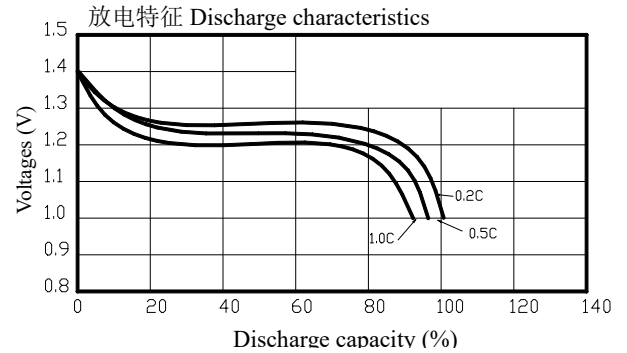
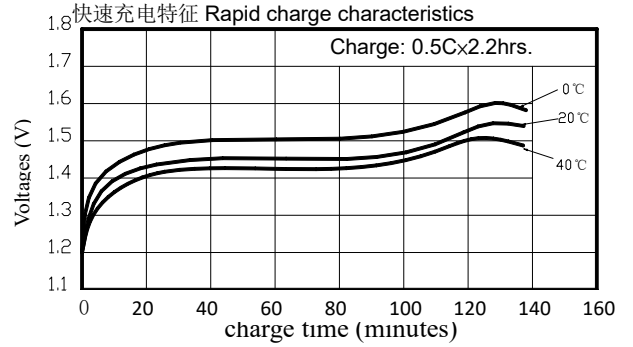
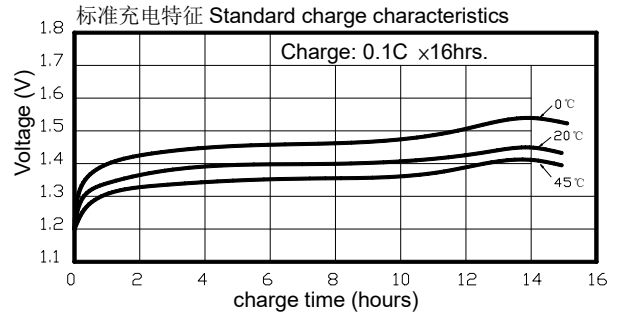

单颗电池尺寸包括 PVC (Dimensions with tube)

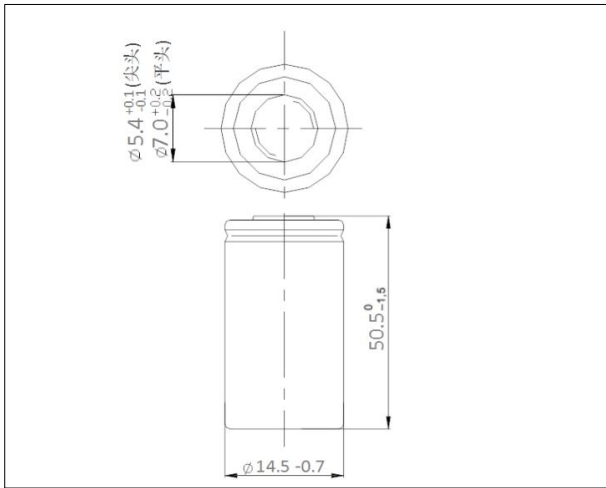

备注 Note:

- 标称容量是指 20°C 时 0.2C 放电容量  
Nominal capacity, rated at 0.2C 20°C.
- 容量只作为参考  
Average capacity, for reference only.
- 重量和内阻也作为参考  
Weight and internal impedance are For reference.
- 寿命测试依照 IEC 标准  
Standard according as IEC of test cycle life.